

Features

- Uses PingWei advanced PerfectMOS technology
- Extremely low on-resistance $R_{DS(on)}$
- Excellent $Q_g \times R_{DS(on)}$ product(FOM)
- Excellent Low Ciss
- Qualified according to JEDEC criteria

Benefits

- High robustness and reliability
- Increases maximum current capability
- Low power loss, high power density
- Easy paralleling

Applications

- Synchronous Rectification for AC/DC Quick Charger
- Battery management
- UPS (Uninterruptible Power Supplies)



100% DVDS Tested
100% Avalanche Tested

Product Summary

V_{DS}	120V
$R_{DS(on)@10V}$ typ	1.8mΩ
I_D	278A

TOLL-1L

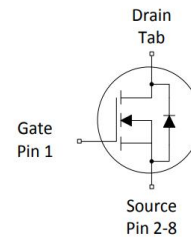
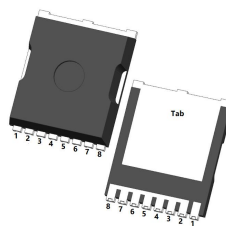

Package Marking and Ordering Information

Part #	Marking	Package	Packing	Reel Size	Tape Width	Qty
PW022N12TS	PW022N12TS	TOLL-1L	Tape&Reel	13 inches	24mm	1500pcs

Absolute Maximum Ratings

Parameter	Symbol	Value	Unit
Drain-source voltage	V_{DS}	120	V
Continuous drain current	I_D	278	A
$T_C = 25^\circ\text{C}$ (Silicon limit)		300	
$T_C = 25^\circ\text{C}$ (Package limit)		176	
$T_C = 100^\circ\text{C}$ (Silicon limit)		18	
$T_a = 25^\circ\text{C}$			
Pulsed drain current ($T_C = 25^\circ\text{C}$)	$I_{D\ pulse}$	1113	A
Avalanche energy, single pulse (L=0.4mH)	E_{AS}	720	mJ
Gate-Source voltage	V_{GS}	± 20	V
Power dissipation	P_{tot}	362	W
$T_C = 25^\circ\text{C}$		1.5	
$T_a = 25^\circ\text{C}$			
Operating junction and storage temperature	T_j, T_{stg}	-55...+150	$^\circ\text{C}$
Soldering temperature, wave soldering only allowed at leads (1.6mm from case for 10s)	T_{sold}	260	$^\circ\text{C}$

Thermal Resistance

Parameter	Symbol	Value			Unit	Test Condition
		min.	typ.	max.		
Thermal resistance, junction – case.	RthJC	-	-	0.35	°C/W	-
Thermal resistance, junction - ambient(min. footprint)	RthJA	-	-	84	°C/W	-

Electrical Characteristic (at Tj = 25 °C, unless otherwise specified)

Parameter	Symbol	Value			Unit	Test Condition
		min.	typ.	max.		

Static Characteristic

Drain-source breakdown voltage	BV_{DSS}	120	-	-	V	$V_{GS}=0V, I_D=250\mu A$
Gate threshold voltage	$V_{GS(th)}$	2.0	-	4.0	V	$V_{DS}=V_{GS}, I_D=250\mu A$
Zero gate voltage drain current	I_{DSS}	-	-	10 100	μA	$V_{DS}=120V, V_{GS}=0V$ $T_j=25^\circ C$ $T_j=150^\circ C$
Gate-source leakage current	I_{GSS}	-	-	± 100	nA	$V_{GS}=\pm 20V, V_{DS}=0V$
Drain-source on-state resistance	$R_{DS(on)}$	-	1.8	2.2	mΩ	$V_{GS}=10V, I_D=20A$
Transconductance	g_{fs}	-	90	-	S	$V_{DS}=5V, I_D=20A$

Dynamic Characteristic

Input Capacitance	C_{iss}	-	11020	-	pF	$V_{GS}=0V, V_{DS}=60V,$ $f=1MHz$
Output Capacitance	C_{oss}	-	1347	-		
Reverse Transfer Capacitance	C_{rss}	-	20	-		
Gate Total Charge	Q_G	-	140	-	nC	$V_{DS}=60V, I_D=20A,$ $V_{GS}=10V$
Gate-Source charge	Q_{gs}	-	40	-		
Gate-Drain charge	Q_{gd}	-	20	-		
Turn-on delay time	$t_{d(on)}$	-	30	-	ns	$V_{GS}=10V, V_{DD}=60V,$ $R_{G_ext}=10\Omega, I_D=20A$
Rise time	t_r	-	20	-		
Turn-off delay time	$t_{d(off)}$	-	51	-		
Fall time	t_f	-	15	-		
Gate resistance	R_G	-	1	-	Ω	$V_{GS}=0V, V_{DS}=0V,$ $f=1MHz$



Body Diode Characteristic

Parameter	Symbol	Value			Unit	Test Condition
		min.	typ.	max.		
Body Diode Forward Voltage	V_{SD}	-	-	1.2	V	$V_{GS}=0V, I_{SD}=20A$
Body Diode Continuous Forward Current	I_S	-	-	278	A	TC = 25°C
Body Diode Pulsed Current	I_S pulse	-	-	1113	A	TC = 25°C
Body Diode Reverse Recovery Time	t_{rr}	-	95	-	ns	$I_F=20A,$ $dI/dt=100A/\mu s$
Body Diode Reverse Recovery Charge	Q_{rr}	-	209	-	nC	

Typical Performance Characteristics

Fig 1: Output Characteristics

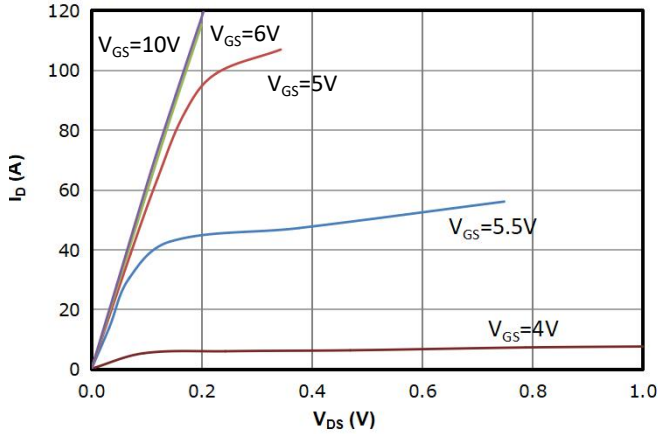

Fig 2: Transfer Characteristics

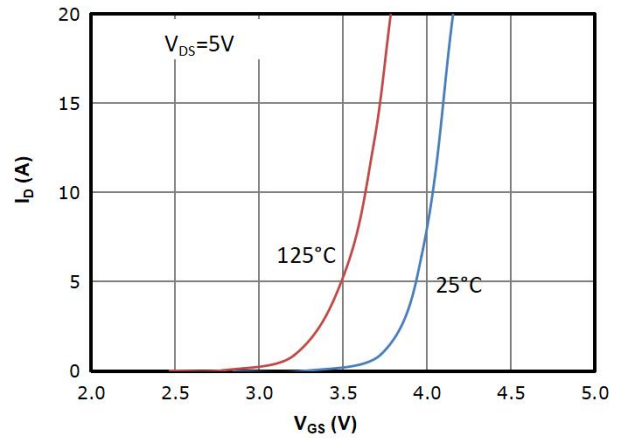

Fig 3: $R_{DS(on)}$ vs Drain Current and Gate Voltage

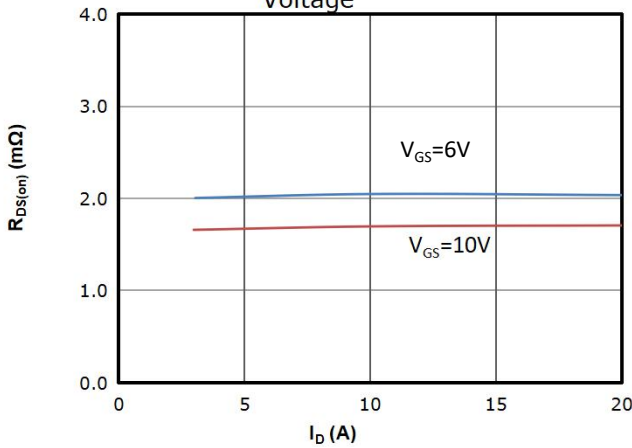

Fig 4: $R_{DS(on)}$ vs Gate Voltage

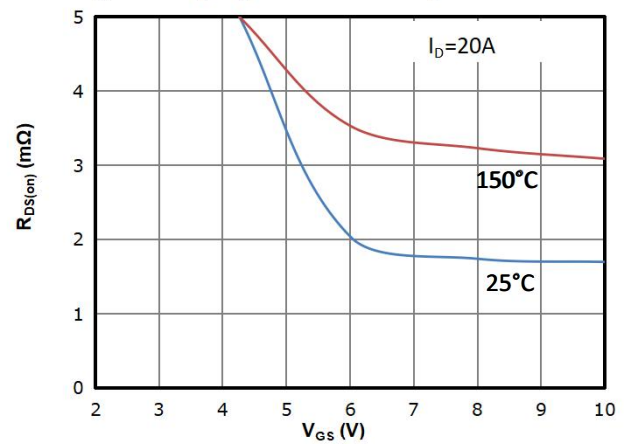

Fig 5: $R_{DS(on)}$ vs. Temperature

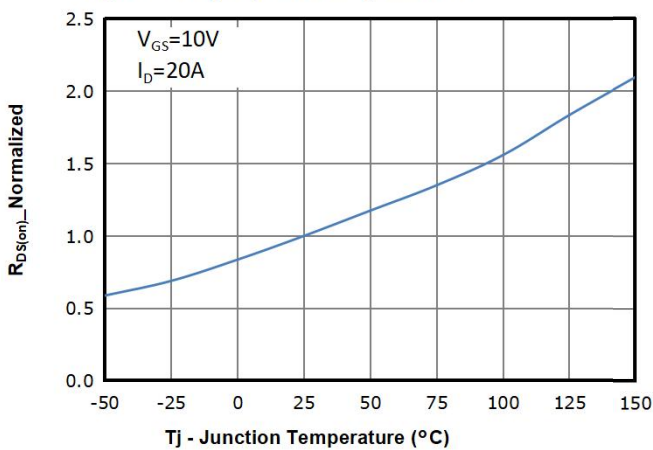

Fig 6: $V_{GS(th)}$ vs. Temperature

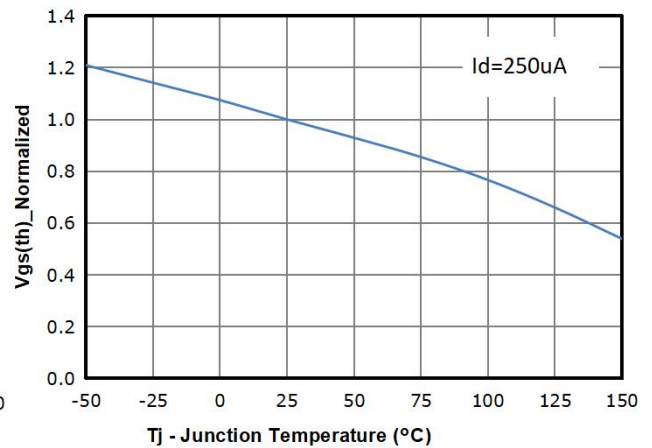

Fig 7: BVdss vs. Temperature

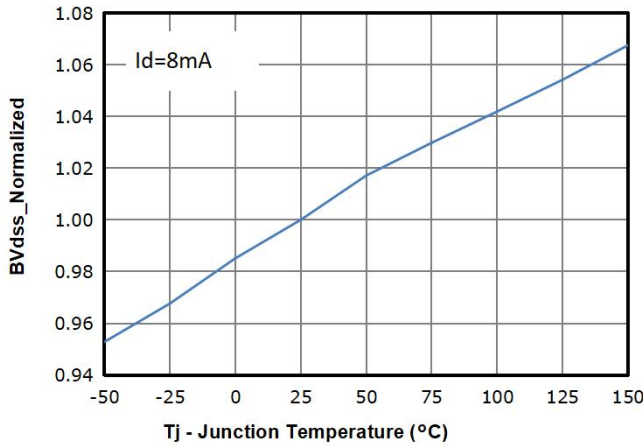

Fig 8: Capacitance Characteristics

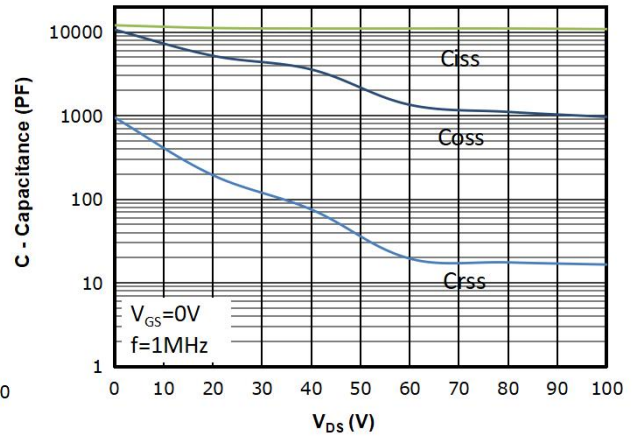

Fig 9: Gate Charge Characteristics

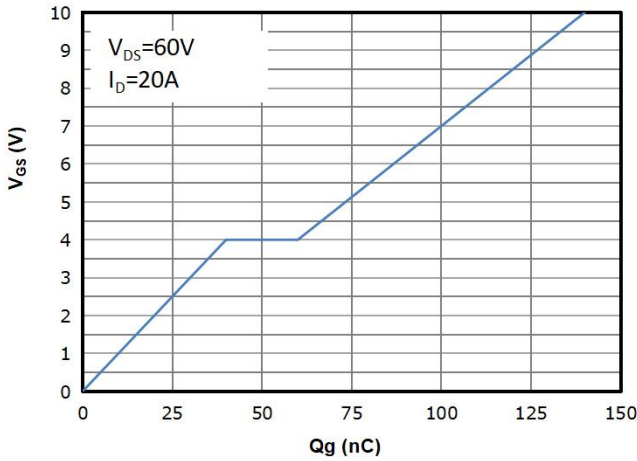

Fig 10: Body-diode Forward Characteristics

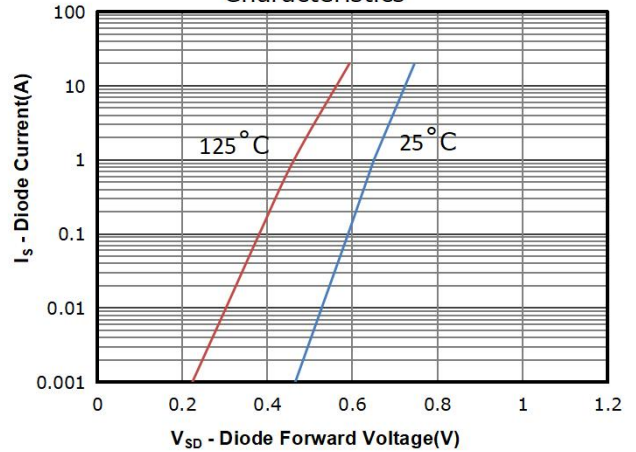

Fig 11: Power Dissipation

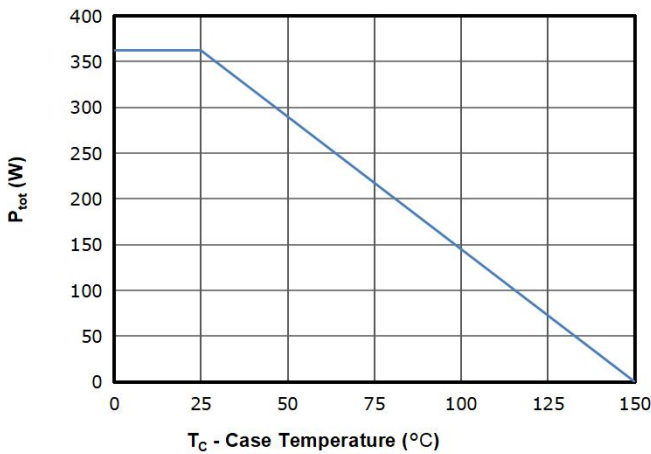

Fig 12: Drain Current Derating

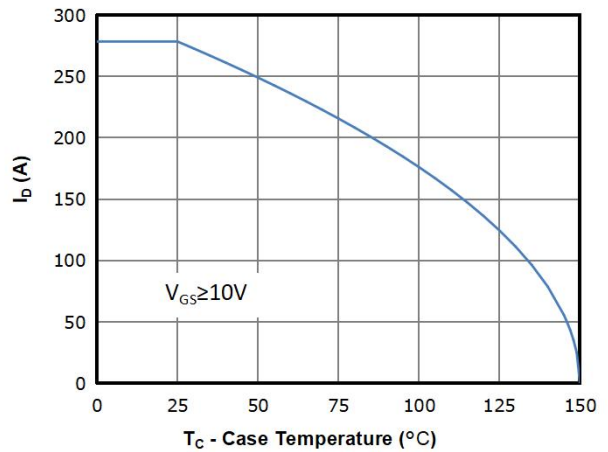

Fig 13: Safe Operating Area

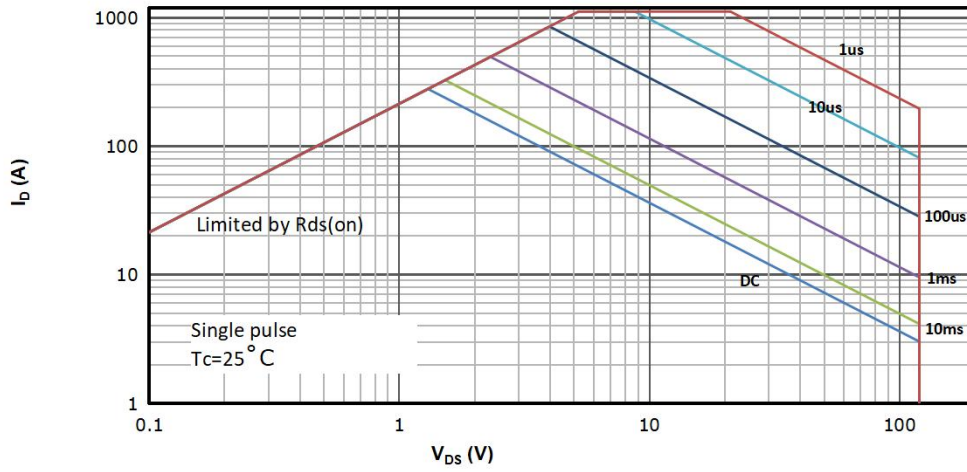
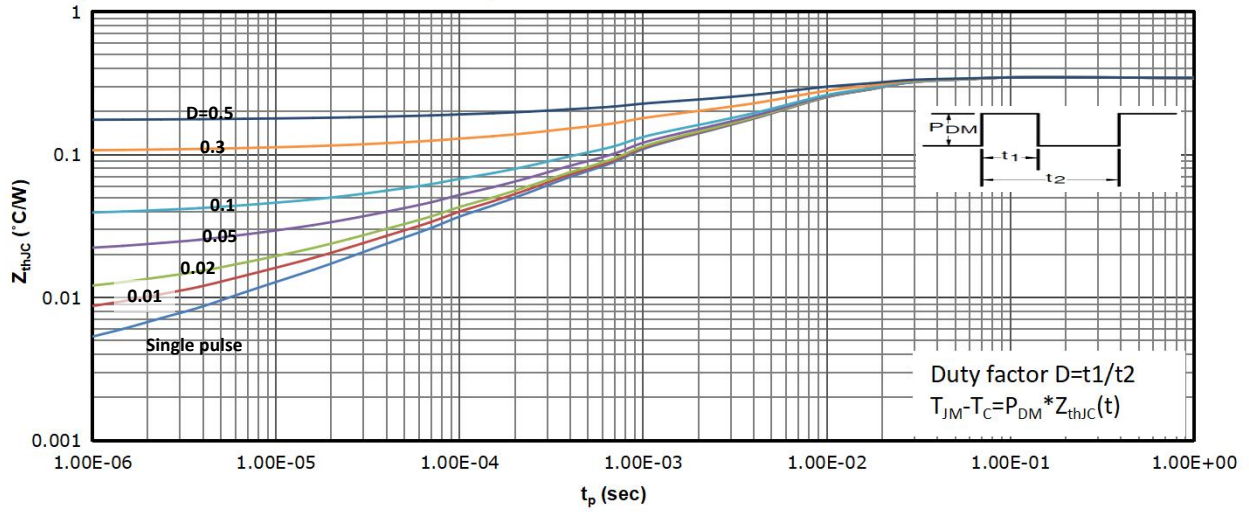

Fig 14: Max. Transient Thermal Impedance



Test Circuit & Waveform

Gate Charge Test Circuit & Waveform



Resistive Switching Test Circuit & Waveforms

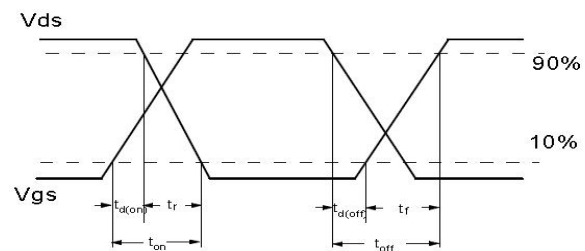

Unclamped Inductive Switching (UIS) Test Circuit & Waveforms

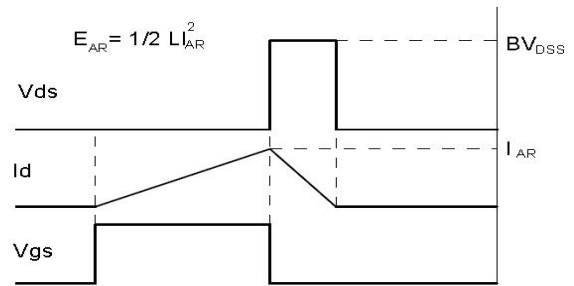

Diode Recovery Test Circuit & Waveforms

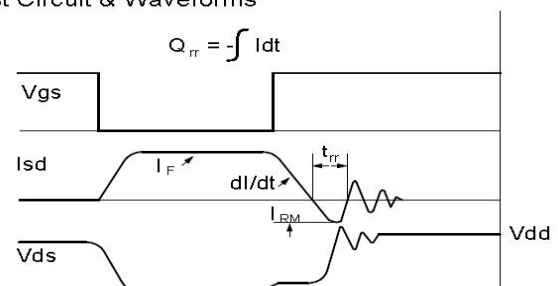

Package Outline: TOLL-1L

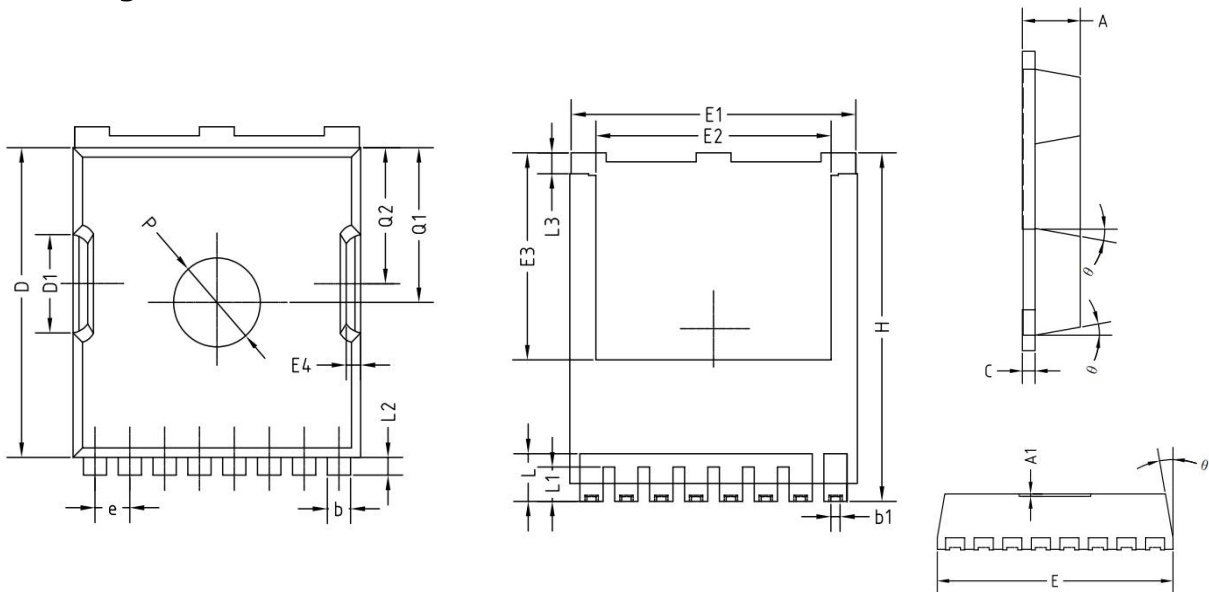

SYMBOL	MILLIMETERS		INCHES	
	MIN	MAX	MIN	MAX
A	2.20	2.40	0.087	0.094
A1	0.05	0.20	0.002	0.008
b	0.65	0.85	0.026	0.033
b1	0.30	0.50	0.012	0.020
C	0.35	0.65	0.014	0.026
D	10.35	10.70	0.407	0.421
D1	3.15	3.45	0.124	0.136
E	9.80	10.00	0.386	0.394
E1	9.65	9.95	0.380	0.392
E2	7.90	8.30	0.311	0.327
E3	6.80	7.20	0.268	0.283
E4	0.30	0.75	0.012	0.030
e	1.15	1.25	0.045	0.049
L	1.35	1.85	0.053	0.073
L1	0.95	1.35	0.037	0.053
L2	0.40	0.80	0.016	0.031
L3	0.60	0.85	0.024	0.033
θ	7°	12°	7°	12°
P	2.90	3.10	0.114	0.122
Q	4.50	4.70	0.177	0.185
Q1	5.10	5.30	0.201	0.209
H	11.55	11.95	0.455	0.470



Revision History

Revision	Date	Major changes
1.0	2023/9/1	Release of Formal Version.

Disclaimer

Any and all semiconductor products have certain probability to fail or malfunction, which may result in personal injury, death or property damage. Customer are solely responsible for providing adequate safe measures when design their systems.

Unless otherwise specified in the datasheet, the product is designed and qualified as a standard commercial product and is not intended for use in applications that require extraordinary levels of quality and reliability, such as automotive, aviation/aerospace and life-support devices or systems.

Buyer is responsible for its products and applications using PingWei products, including compliance with all laws, regulations and safety requirements or standards, regardless of any support or applications information provided by PingWei.

“Typical” parameters which may be provided in PingWei data sheets and/or specifications can and do vary in different applications and actual performance may vary over time. All operating parameters, including “Typicals” must be validated for each customer application by customer’s technical experts

ALL PRODUCT, PRODUCT SPECIFICATIONS AND DATA ARE SUBJECT TO CHANGE WITHOUT NOTICE TO IMPROVE RELIABILITY, FUNCTION OR DESIGN OR OTHERWISE